

POS	Q	N° PARTE	DESCRIZIONE
1	1	001049-01	BASAMENTO
2	1	001049-03	ALBERO
3	1	MA-N05-MUN151221	FRIZIONE OGURA
4	1	ESTERNO D30	SEEGER
5	1	UNI 6606 - 4x6,5	Linguetta a disco
6	1	30BD40DF2	CUSCINETTO NSK
7	1	SKF6005	CUSCINETTO SKF
8	1	SKF6004	CUSCINETTO SKF
9	1	30X42X07	PARAOLIO
10	3	UNI 5931-M6x12	Vite cilindrica
11	1	8x20x4	RONDELLA
12	1	UNI 5739-M8x30	Vite esagonale
13	3	DIN 9021 - 5,3	Rondella
14	1	ESTERNO D25	SEEGER
15	1	FASCETTA	FASCETTA
16	1	ISO 4762 - M5x8	Vite cilindrica

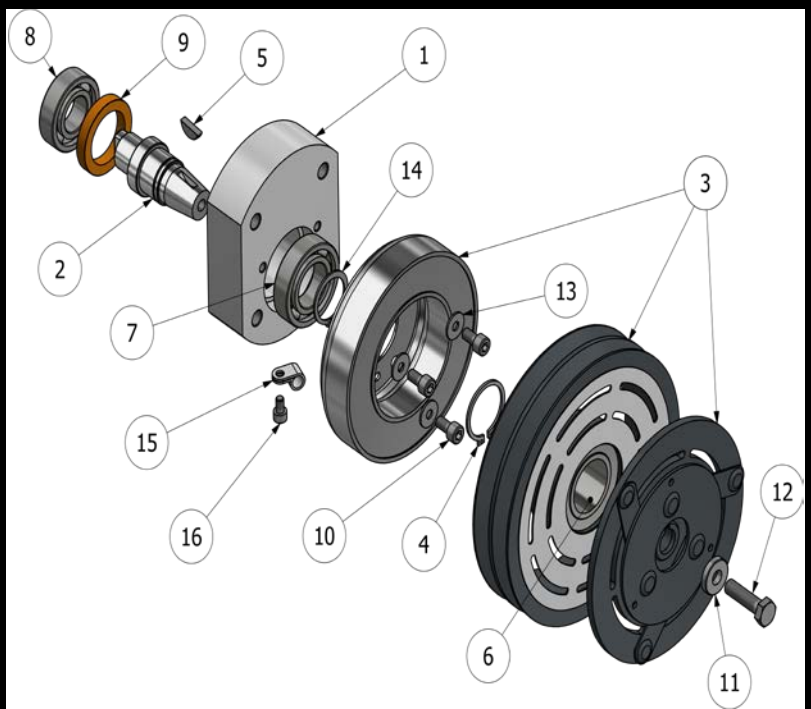

CARATTERISTICHE TECNICHE

Tensione di alimentazione	Volt	24
Assorbimento	Amp.	1.9
Consumo energetico massimo	Watt	47
Velocità massima	Rpm	6000
Trazione	Nm	108
Diametro puleggia	mm	152
Tipo puleggia	Vbelt	2
Tipo giunto	Croce	H12