

POS	Q	NUMERO PARTE	DESCRIZIONE
1	1	00107801	BASAMENTO
2	1	00107802	ALBERO
3	2	ESTERNO D 25	SEEGER
4	1	SKF NA4905 RS	CUSCINETTO A RULLI
5	1	SKF 6005	CUSCINETTO SKF
6	1	UNI 6606 4x6,5	LINGUETTA A DISCO
7	3	UNI 5931 - M 6 x 10	Vite a testa cilindrica
8	3	08x20x04	RONDELLA
9	1	UNI 5739 - M8 x 30	Vite a testa esagonale
10	1	30BD40DF2	CUSCINETTO NSK
11	1	MA-N05-MUN 151221	FRIZIONE OGURA
12	1	ESTERNO D30	SEEGER
13	3	DIN 9021 - 5,3	Rondella

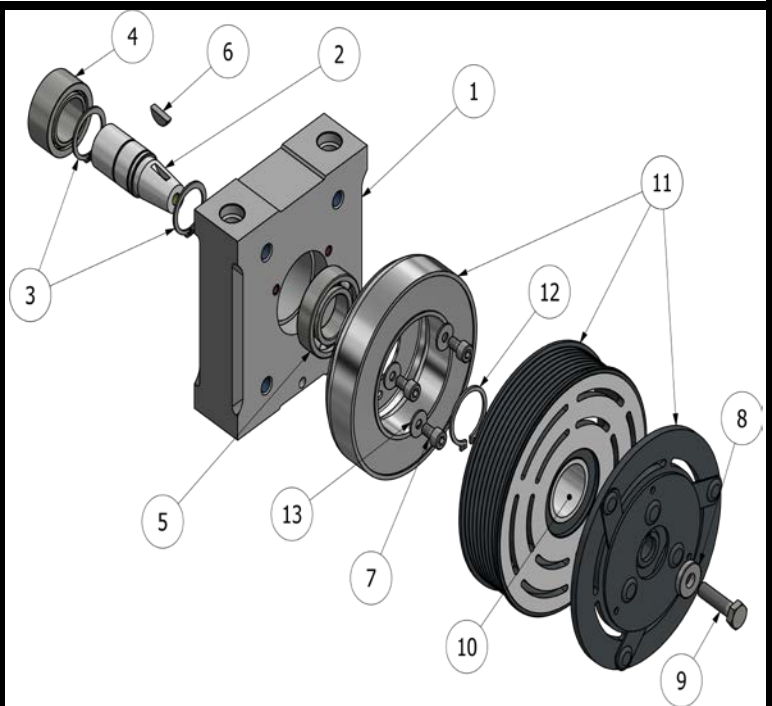

CARATTERISTICHE TECNICHE

Tensione di alimentazione	Volt	24
Assorbimento	Amp.	1.9
Consumo energetico massimo	Watt	47
Velocità massima	Rpm	6000
Trazione	Nm	108
Diametro puleggia	mm	134
Tipo puleggia	poliV	8
Tipo giunto	SAE	9T 16/32