

POS	Q	NUMERO PARTE	DESCRIZIONE
1	1	001081-01	BASAMENTO
2	1	001081-02	MOZZO
3	1	001081-03	ALBERO
4	1	STN 022930 - 38	SEEGER
5	1	STN 022930 - 48	SEEGER
6	4	UNI 5933 -M6x16	Vite svasata
7	1	MS 16625 - 1.575	SEEGER INTERNO
8	1	SKF6203	CUSCINETTO
9	1	DIN 6885 - A 4 x 4 x 12	Chiavetta parallela
10	1	53724700-4	FRIZIONE OGURA
11	1	NSK 40BD219DUK	CUSCINETTO
12	1	8.5X20X4	RONDELLA
13	1	UNI 5739 - M8 x 20	Vite a testa esagonale
14	1	JIS B 1536 SKF - SKF NA 4903.2RS	Cuscinetto a rulli

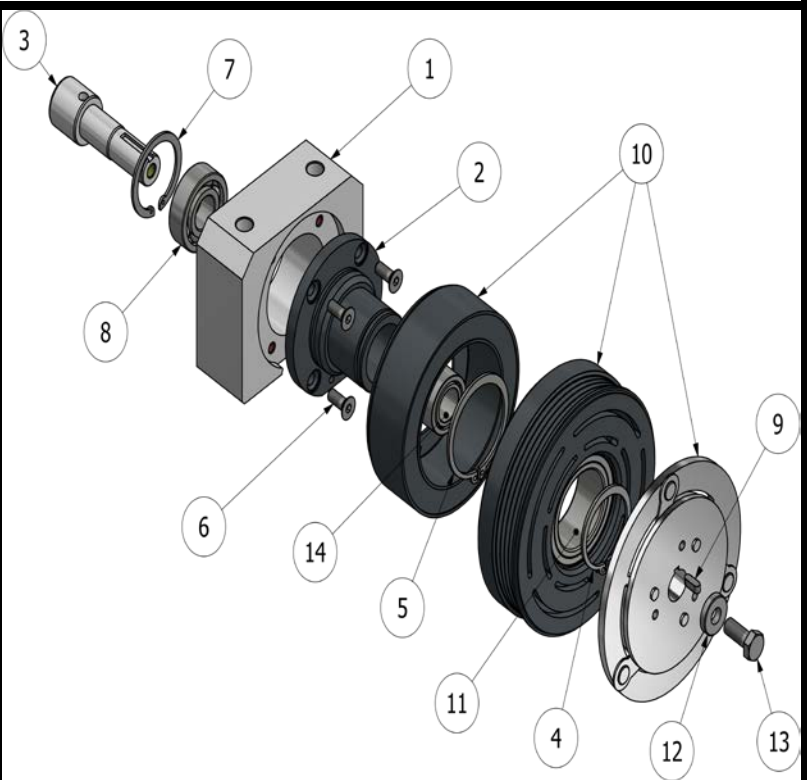

CARATTERISTICHE TECNICHE

Tensione di alimentazione	Volt	12
Assorbimento	Amp.	3.7
Consumo energetico massimo	Watt	47
Velocità massima	Rpm	6000
Trazione	Nm	60
Diametro puleggia	mm	120
Tipo puleggia	poliV	4