

POS	Q	N° PARTE	DESCRIZIONE
1	1	00126101	BASAMENTO
2	1	00126102	MOZZO
3	1	00126103	ALBERO
4	1	17.2X25X9.8	DISTANZIALE
5	1	EX D 42.5	SEEGER INT.
6	1	EX D. 36	SEEGER
7	1	FERMA FILO	FASCETTA
8	3	UNI 5933 - M6 x 16	Vite svasata
9	1	SKF A-2RS1	CUSCINETTO
10	1	EX D. 45	SEEGER
11	1	NSK 40BD219DUK	CUSCINETTO
12	1	8.5X20X4	RONDELLA
13	1	A 4 x 4 x 16	Chiavetta
14	1	53724700-4	FRIZIONE OGURA
15	1	UNI 5739 - M8 x 25	Vite a testa esagonale
16	1	ISO 4762 - M5 x 8	Vite con esag. incassato

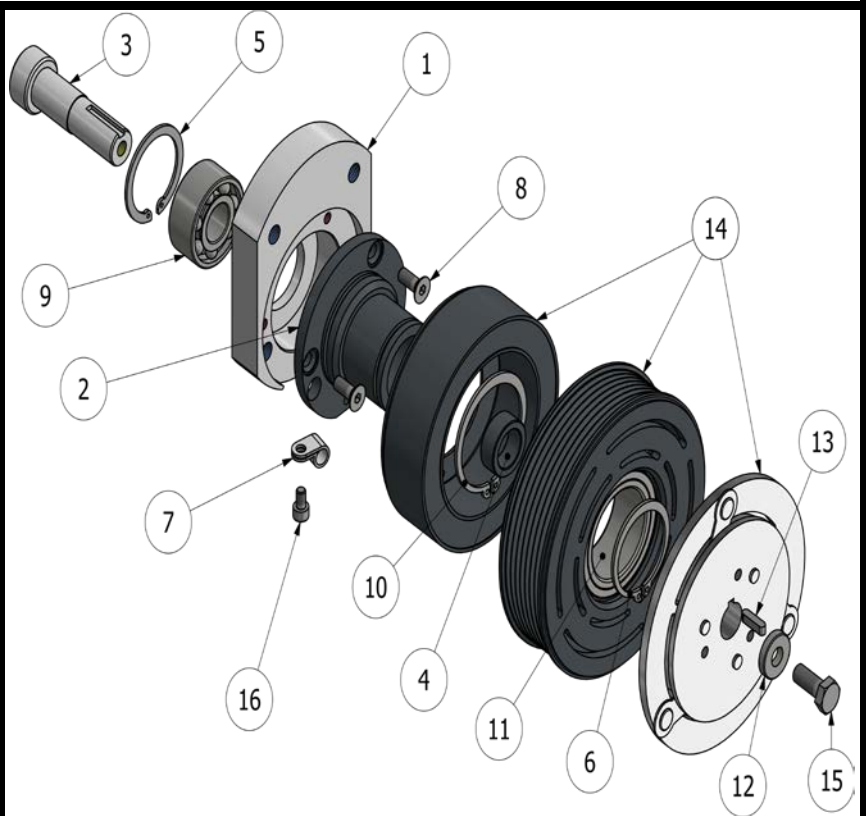

CARATTERISTICHE TECNICHE

Tensione di alimentazione	Volt	12
Assorbimento	Amp.	3.7
Consumo energetico massimo	Watt	47
Velocità massima	Rpm	6000
Trazione	Nm	60
Diametro puleggia	mm	120
Tipo puleggia	poliV	7