

POS.	Q	NUMERO PARTE	DESCRIZIONE
1	1	00106801	BASAMENTO
2	1	00106805	ALBERO
3	1	MA-N05-MUN 151221	FRIZIONE OGURA
4	1	ESTERNO D30	SEEGER
5	1	UNI 6606 - 4 x 6,5	Linguetta a disco
6	1	30BD40DF2	CUSCINETTO NSK
7	2	SKF6005	CUSCINETTO SKF
8	3	UNI 5931 - M 6 x 12	Vite a testa cilindrica
9	1	8x20x4	RONDELLA
10	1	UNI 5739 - M8 x 30	Vite a testa esagonale
11	3	DIN 9021 - 5,3	Rondella
12	2	ESTERNO D25	SEEGER

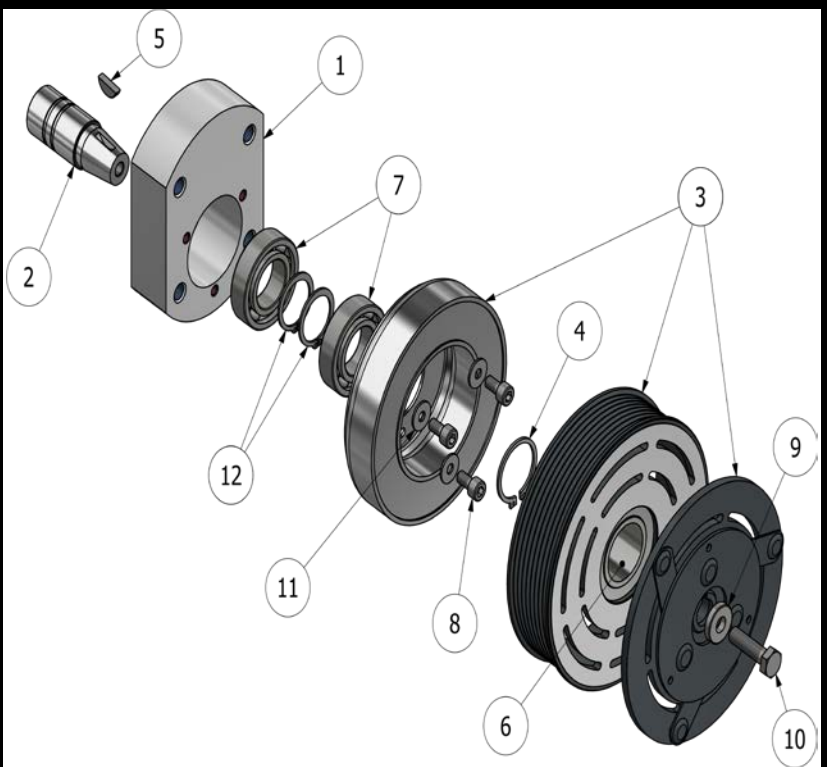

CARATTERISTICHE TECNICHE

Tensione di alimentazione	Volt	24
Assorbimento	Amp.	1.9
Consumo energetico massimo	Watt	47
Velocità massima	Rpm	6000
Trazione	Nm	108
Diametro puleggia	mm	134
Tipo puleggia	poliV	8