

N°	DESCRIZIONE	Q.	CODICE PARTE
1	Vite cilindrica	4	M 8 x 25
2	Rondella	4	zigrinata §8
3	Staffa	1	00130102
4	Paraolio	1	456007
5	Cuscinetto a sfere	2	SKF 6009
6	Seeger	2	D E45 alto
7	Albero	1	00130103
8	Linguetta disco	1	4 x 6.5
9	Basamento	1	00130101
10	Paraolio	1	304007
11	Frizione OGURA 108Nm	2	MA-N05-MUN151221
12	Rondella piana	3	6.5x17.6x1.3
13	Vite testa a bottone	3	M6 x 10
14	Rondella piana	1	8X20X4
15	Vite esagonale	1	M8 x 30

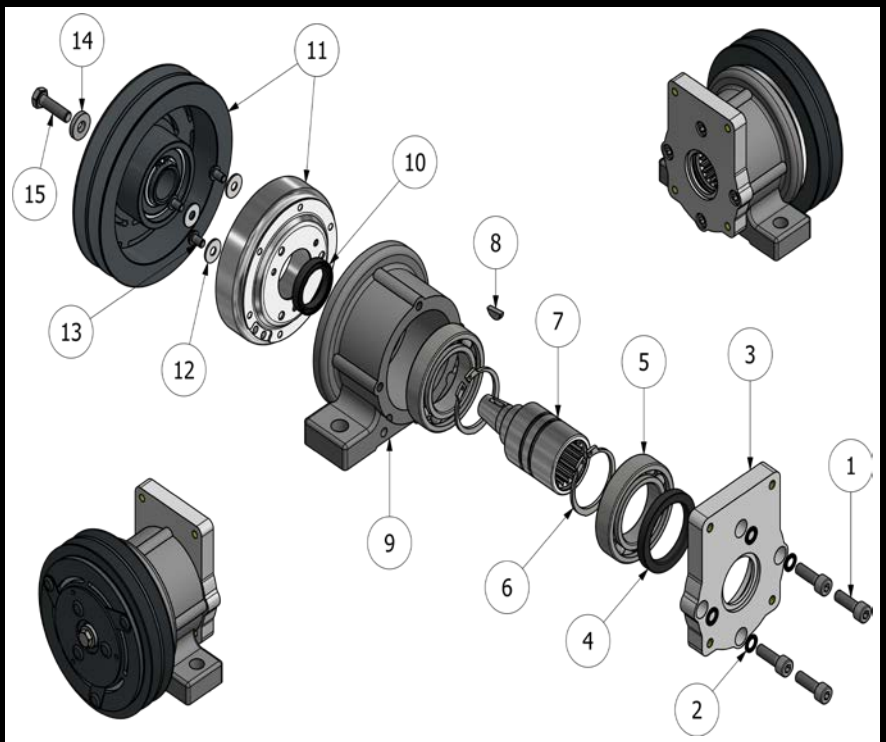

CARATTERISTICHE TECNICHE		
Tensione di alimentazione	Volt	12
Assorbimento	Amp.	3.7
Consumo energetico massimo	Watt	47
Velocità massima	Rpm	6000
Trazione	Nm	108
Diametro puleggia	mm	152
Tipo puleggia	Vbelt	2
Tipo giunto	scanalato	10012