

N°	DESCRIZIONE	Q.	CODICE PARTE
1	Vite esagonale	1	M8 x 20
2	Rondella piana	1	8X20X4
3	Chiavetta parallela	1	4 x 4 x 16
4	Seeger	1	ES. D 36
5	Frizione Ogura	1	53724700-4
6	Seeger	1	ES. D 45
7	Spina elastica	1	4 x 10
8	Vite svasata	3	M6 x 14
9	Basamento	1	00127201
10	Cuscinetto a sfera	1	SKF 2RS161804
11	Distanziale	1	20x26x3
12	Cuscinetto a sfera	1	SKF 2RS161904
13	Albero	1	00127203
14	Seeger	1	IN. D 39

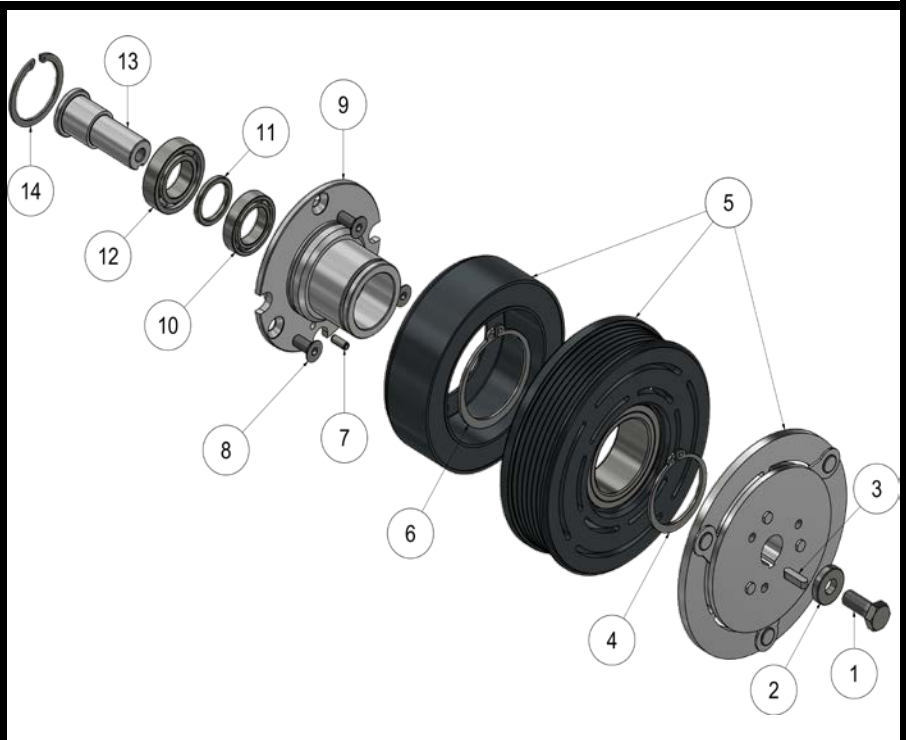

CARATTERISTICHE TECNICHE		
Tensione di alimentazione	Volt	12
Assorbimento	Amp.	3.7
Consumo energetico massimo	Watt	47
Velocità massima	Rpm	6000
Trazione	Nm	60
Diametro puleggia	mm	120
Tipo puleggia	poliV	6